

# TOMCAT®

Handmade in U.S.A. - Est 1986

Premium Sweepers

GT | VR v2.0



\*Images could include non-standard options. Subject to change without notice.

**Family-Owned & Operated**



Scrubbers

Sweepers

# Choose Your VR Controller

## Touch Screen Controller

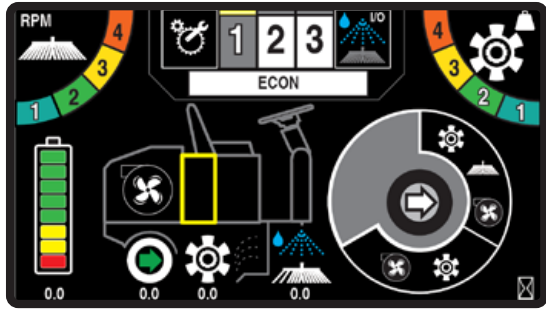

## 2010's technology Actuators



## Gauges & Toggles



## 2000's technology Manual Levers

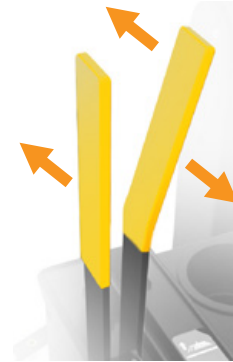

## Applications

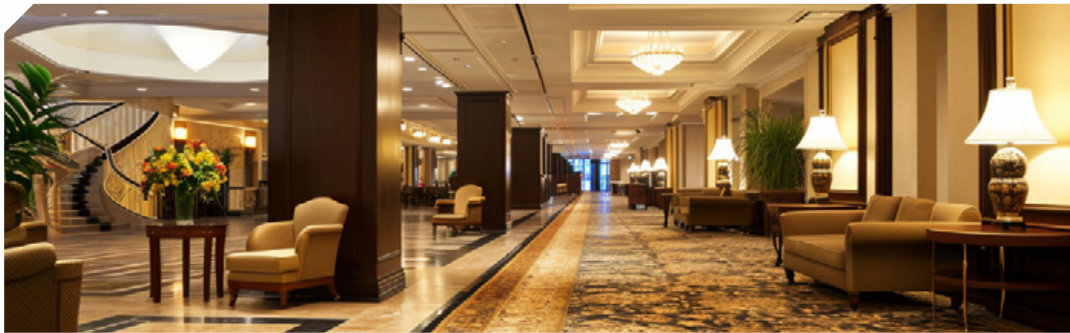

## Hotels

Regular sweeping is crucial in preserving the pristine condition of carpeted floors and areas frequented by guests. This not only upholds the hotel's aesthetic appeal but also contributes to a hygienic environment. Additionally, using sweepers significantly cuts down on time and labor, boosting the hotel's operational efficiency and enabling staff to focus on providing top-notch hospitality.

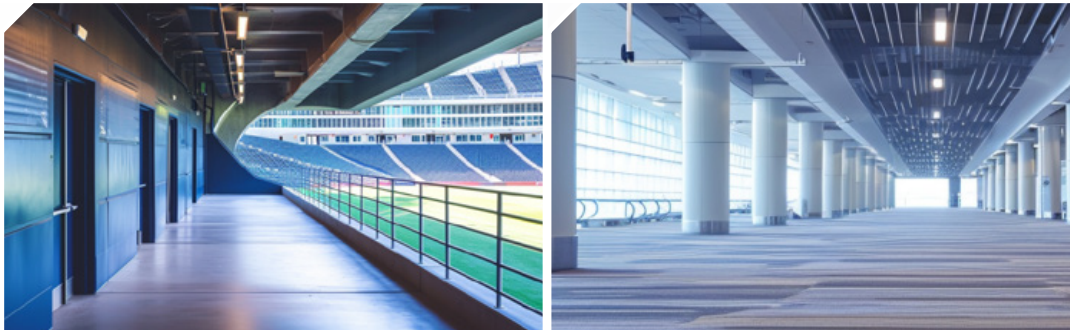

## Stadiums/Airports

Sweepers efficiently manage debris, trash, and dirt. This ensures a clean, attractive environment for visitors and staff. Capable of handling both fine particles and larger waste, they maintain safety and comfort in high-traffic areas. Halls in stadiums and expansive terminal areas in airports are kept pristine, contributing to a positive visitor experience. These sweepers also enhance operational efficiency by saving significant time and labor in these busy public venues.



## Warehouse

In warehouses, sweepers are crucial for efficiently managing debris, trash, and dirt, ensuring a clean and safe environment. They effectively handle various waste sizes, essential for maintaining clear aisles and workspaces. Regular use of sweepers keeps floors in optimal condition, vital in high-traffic areas. Additionally, these sweepers significantly reduce cleaning time and labor, boosting operational efficiency in these busy logistics hubs.

# Under The Hood VR v2.0

## GT

Self Propelled

Stainless Handlebar

Oversized Battery

Baghouse Filter

Steel Body

Powerful Side Broom

900 lb capacity caster



Fan housing exhausts into tank mold with optional filtered vac exhaust

Premium Batteries

Optional Remote Vac

Adjustable Steering & Seat

Poly Battery Box

Charger

Baghouse Filter

Optional Exhaust Filters

Steel Rim HD Tires

Brooms Actuators

Direct throw 11" main broom

Steel Front Apron

19" Side Brooms

Light Weight Aluminum / Stainless Hopper

# You Be The Judge

Optional Exhaust Filters

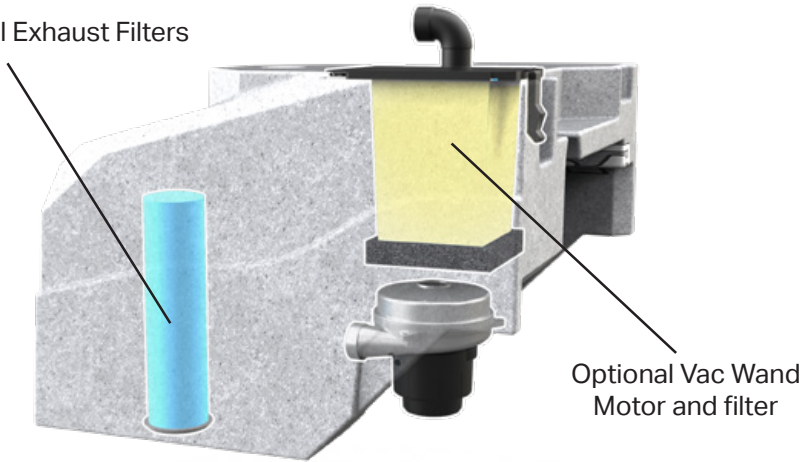

## Patent Pending Hood

- Main fan housing exhaust into hoods interior reducing noise levels. The optional secondary exhaust filters raise air quality to even higher levels, benefiting the operator and others nearby.
- An optional remote hand vac wand system is molded into the hood, eliminating bulky and visibility impairing secondary boxes. A dedicated 6.5" vac motor pulls loose debris into a paper vacuum bag, allowing operator to dispose without contacting litter.

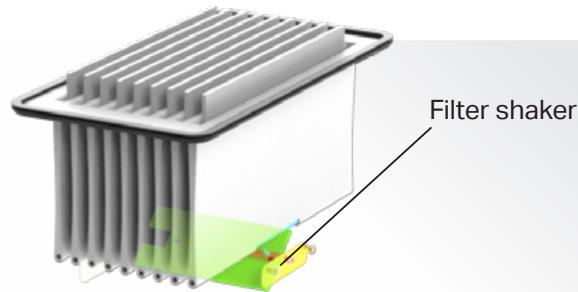

## Baghouse Filter

- Our polymer felt baghouse filter offers longer life and therefore reduced cost compared to cheaper paper panel filters. Similar to what is found in large street sweepers, our baghouse filters have superior dust capacity and lower the chances the main broom creates dust while sweeping.

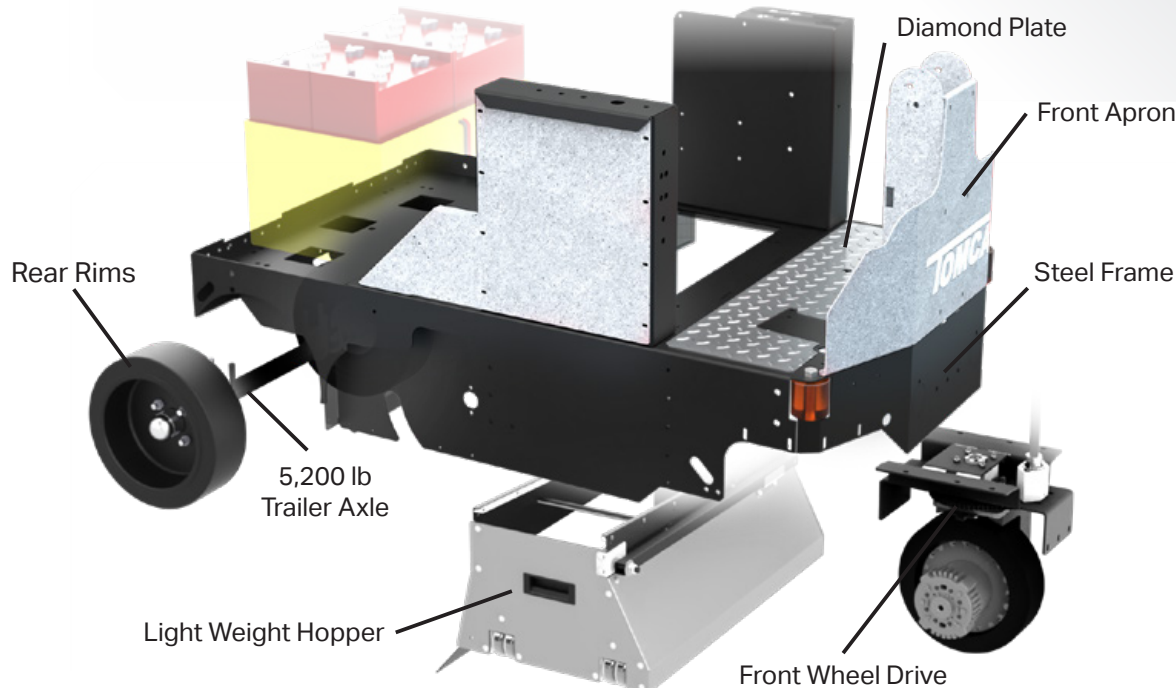

## Heavy Steel Construction

- The thick steel frame supports the oversized battery pack and is supported by a 5,200 lb trailer axle with steel rimmed tires. Large tie down points for transport and steel apron offer the operator foot protection. Instead of cheaper grip tape that wear out quickly our TR uses aluminum Diamond plate for the high traffic footwell.

## 34 & VR Shared Options



### Grey Tires

- Non-marking tires available for more sensitive floor coverings or coatings.

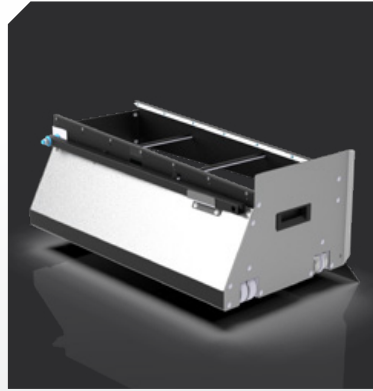

### Light Weight Stainless Hopper

- highest corrosion resistance for applications with harsh debris or operational floor environment (road salt, fertilizer production, chemical packaging, etc..)

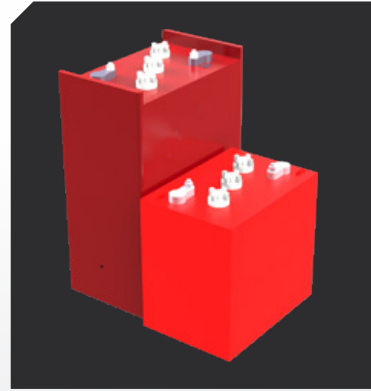

### Batteries

- Wide range of battery sizes and types to match individual customer runtime and maintenance expectations.



### HD Bumpers

- Superior protection against collisions with steel racking, posts or other industrial obstacles.

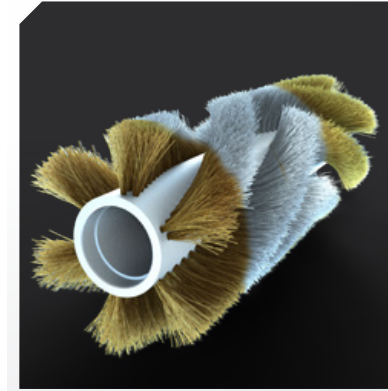

### Broom Fiber Selection

- Range of fibers from softest (tennis courts) through medium (dust control) and up to toughest (outdoors).

## VR Only Options



### Overhead Guard

- Offers operator protection from falling objects and ideal in modern high ceiling distribution centers.

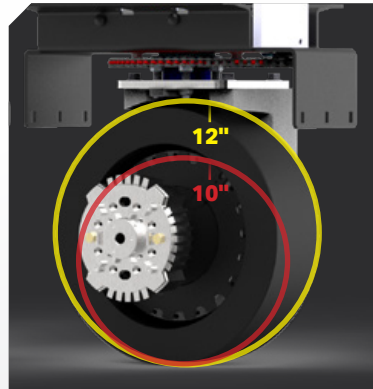

### 12" Front Wheel Drive

- Heavy duty larger drive tire

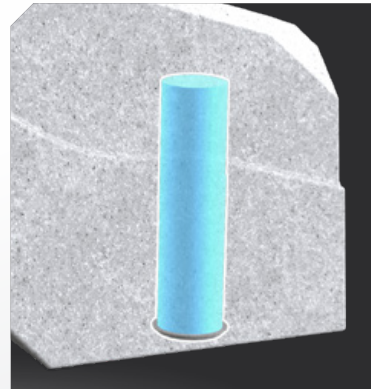

### Secondary Exhaust Filters

- Provide additional dust control and are easily removed for cleaning when needed.

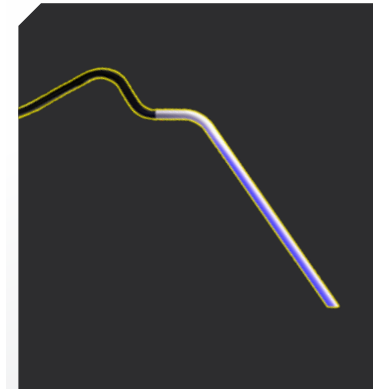

### Vac Wand

- Extends the operators cleaning while seated or from the floor to clean under racking. Suitable for loose dry debris, not fluid spills.

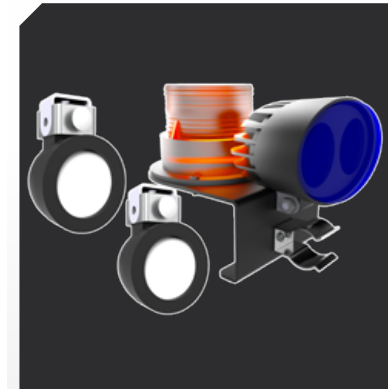

### Lights / Strobes

- Operator controlled dual led headlights, or key switch activated flashing strobe and forward alerting floor spotlight.

# Our Family's American Dream

RPS has been family owned from it's inception in 1986, and proudly builds in Wisconsin (USA). The company has grown over the last 35-years with a strong group of executives including the 2nd generation of family owners who started in the shop as youngsters.



Authorized Distributor

## Assembled By Hand

Our American workforce hand builds each machine with components sourced over 95% from American suppliers. We routinely pay more for these domestically supplied components required to build a superior product. All design, prototyping, production and testing is done in-house where we can best control quality.

MODEL	WALK BEHIND GT	RIDER VR v2.0
<b>BODY CONSTRUCTION / DIMENSIONS</b>		
Chassis Construction:	1/8" (3 mm) Powder Coated Steel	3/16" (5 mm) Powder Coated Steel
Front Wheel (Diameter x Width):	6" x 2" (15 x 5 cm)	10" x 3" (25 x 8 cm) Optional 12" x 4" (31 x 10 cm)
Rear Wheels (Diameter x Width):	(2x) 10" x 2" ((2x) 25 x 5 cm)	(2x) 14" x 5" ((2x) 36 x 13 cm)
Size (L x W x H):	58" x 31" x 38" (147 x 79 x 96 cm)	64" x 37" x 50" (163 x 94 x 140 cm)
Weight (w/ Standard Batteries):	425 - 475 lbs (193 - 215 kg)	1,115 - 1,165 lbs (506 - 528 kg)
<b>SWEEPING SYSTEM</b>		
Broom (Diameter x Length):	10" x 26" (25 - 66 cm)	11" x 32" (25 x 81 cm)
Broom Power / Speed:	1.0 hp / 400 rpm (746 watts)	1.0 hp / 435 rpm (746 watts)
Side Broom Size:	(1x) 17" (43 cm)	(2x) 19" ((2x) 43 cm)
Hopper Capacity:	2.0 cubic ft. (56 liters)	4.2 cubic ft. (116 liters)
<b>POWER SYSTEM</b>		
System Power:	12 VDC - 175 ah	24 VDC - 240 ah
Optional Battery:	215 ah AGM	Up to / 420 ah WET / 390 ah AGM
Run Time:	Up to 5 Hours**	Up to 5 Hours**
<small>**Run times are based on continuous sweeping run times.</small>		
<b>DRIVE SYSTEM:</b>		
Power:	1.0 hp - All Gear / Sealed (745 watts)	1.0 hp - All Gear / Sealed (745 watts)
Speed Control:	0 - 237.6 ft/min / 0 - 2.7 mph (0 - 72.4 m/min / 0 - 4.3 km/h)	0 - 308 ft/min / 0 - 3.5 mph (0 - 93.9 m/min / 0 - 5.6 km/h)
<b>FILTERING SYSTEMS:</b>		
Filtering Material:	Polymer Felt/Baghouse	Polymer Felt/Baghouse
Filter Rating:	1 Micron	1 Micron
Size:	5,192 sq. inches (3.35 sqm)	5,192 sq. inches (3.35 sqm)
Vacuum Specs (Airflow):	250 cfm	280 cfm
<b>GENERAL:</b>		
Cleaning Width:	34" (86 cm)	48" (121 cm)
Decibels:	61 dBA***	65 dB***
<small>***Decibel levels per ISO 11201 as recommended by the American Association of Cleaning Equipment Manufacturers &amp; OSHA</small>		
Productivity - Theoretical:	Up to 21,316 sqft (1,980 sqm)****	Up to 75,000 sqft (6,968 sqm)****
<small>****Productivity is based off of ISSA 2010 Cleaning Times</small>		
Productivity - Practical:	Up to 17,647 sqft (1,639 sqm)****	Up to 59,406 sqft (5,519 sqm)****
<small>****Productivity is based off of ISSA 2010 Cleaning Times</small>		